

# Snake

Designed by Jo Nakashima

<http://jonakashima.com.br>  
<http://www.youtube.com/jonakashima>

Date: February/2010

Difficulty Level: 2/5

Video: <http://youtu.be/GbhkXHPmvdM>

Paper: 10cm x 10cm

- Standard paper
- Tissue foil
- Wet folding

## Body block

You can make as many modules as you want! Each module will be a block of the body, and two of them will be a little different to make the head and tail. To make a nice snake, it is recommended at least 10 modules.

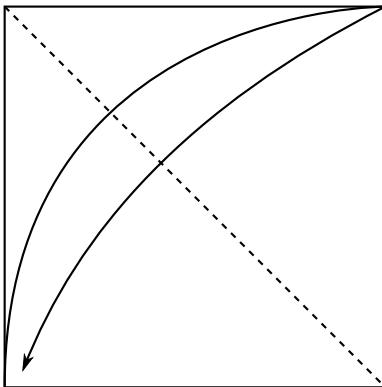

1. Fold along the diagonal

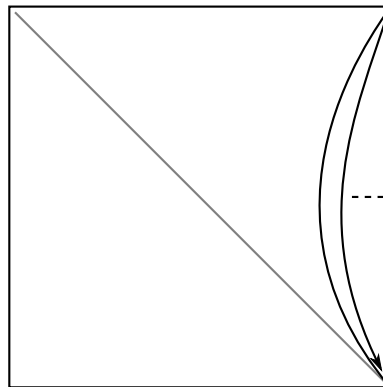

2. Make a pinch

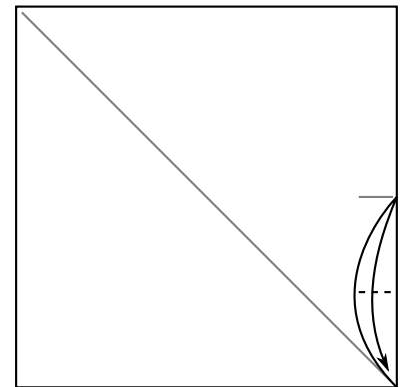

3. Make a pinch

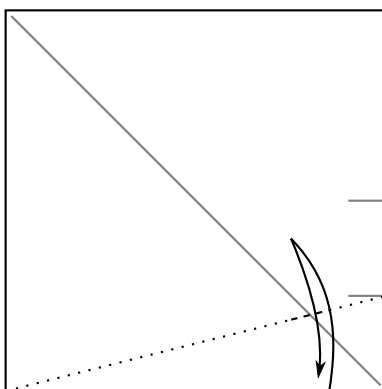

4. Fold along the line that connects the bottom left corner and the last pinch mark. Make a pinch

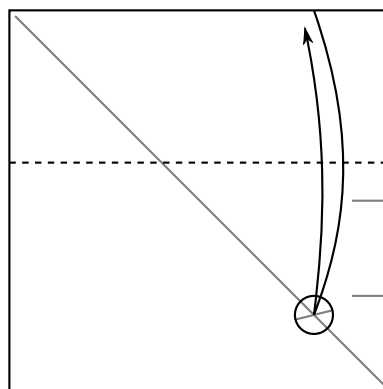

5. Fold the top edge to the pinch mark and unfold

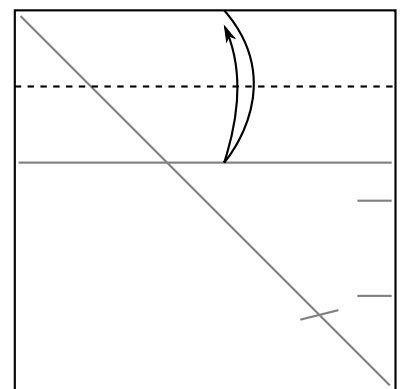

6. Fold the top edge down to the crease you just made and unfold

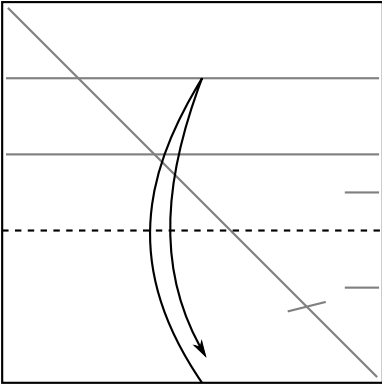

7. Fold the bottom edge up to the crease you just made and unfold

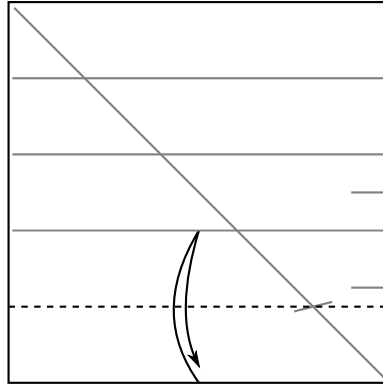

8. Fold the bottom edge up to the crease you just made and unfold

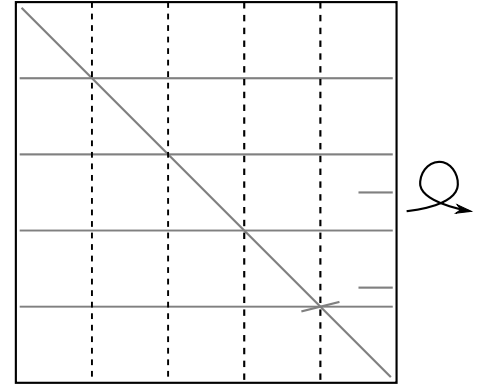

9. Repeat steps 5-8 vertically. Turn over

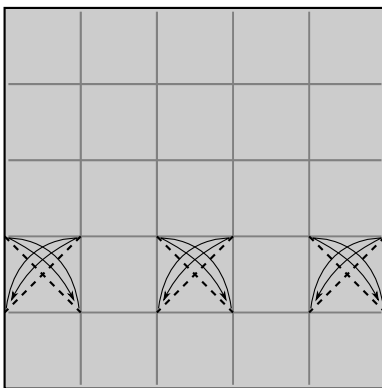

10. Crease the diagonals of little squares

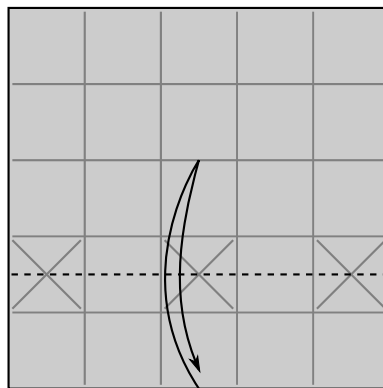

11. Fold the bottom edge up and unfold. Turn over

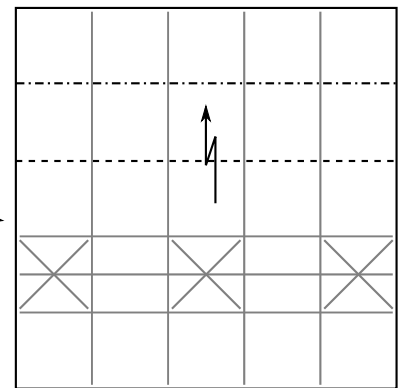

12. Pleat-fold

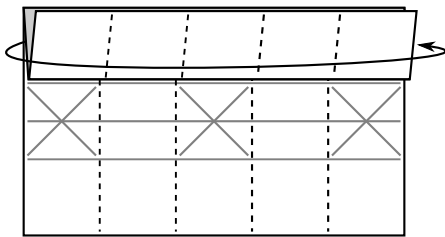

13. Valley-fold at vertical creases. Step 14 shows this step halfway done

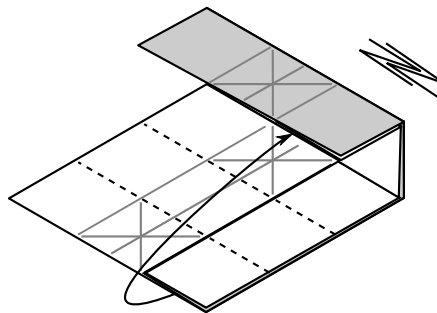

14. Tuck one end into another using the pleat

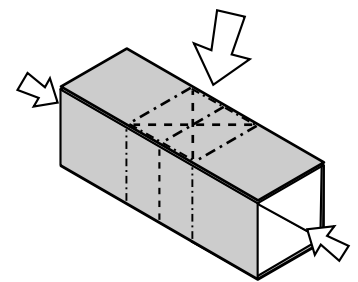

15. Collapse like Waterbomb bases at top and bottom

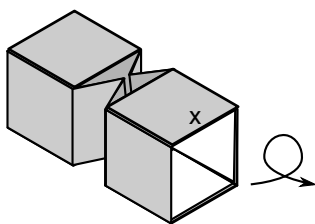

16. Turn over

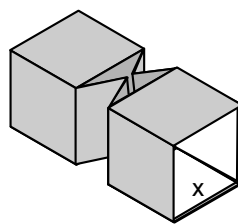

17. Body module finished

# Tail

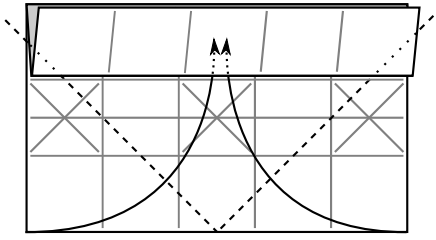

18. Unfold a module to step 13.  
Fold bottom corners to the center, below the pleat fold

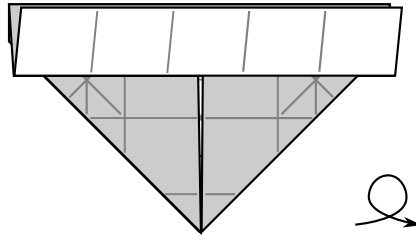

19. Turn over

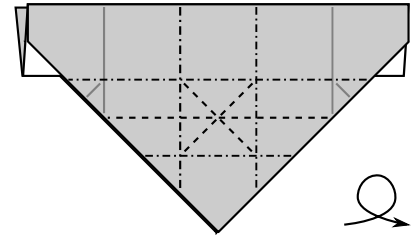

20. Crease through all the layers on existing creases.  
Turn over

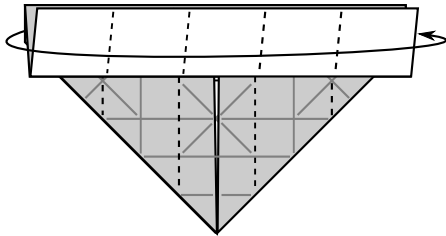

21. Tuck the ends like steps  
13-14

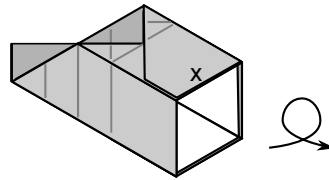

22. Turn over

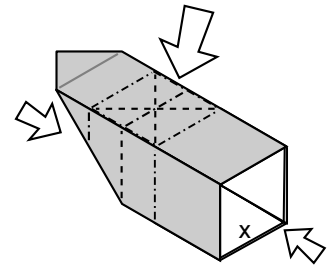

23. Collapse the Waterbomb  
base

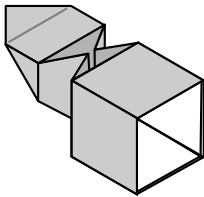

24. Tail module finished

# Head

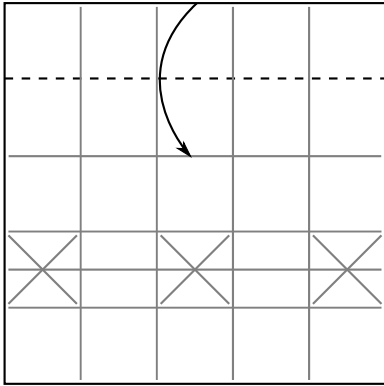

25. Unfold a module to step 13.  
Valley-fold the top edge

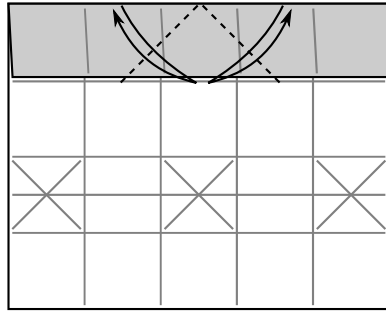

26. Valley-fold

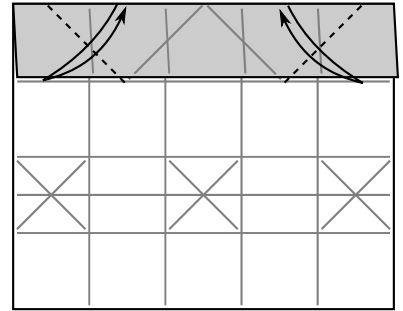

27. Valley-fold

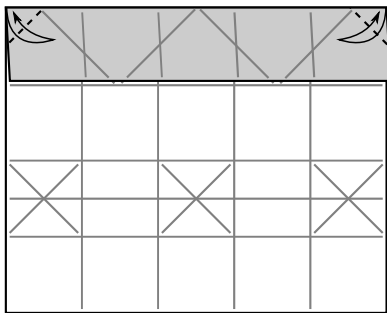

28. Valley-fold

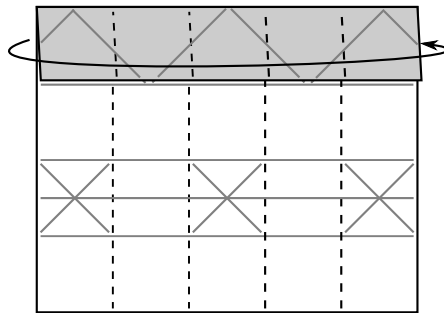

29. Tuck the ends like steps  
13-14

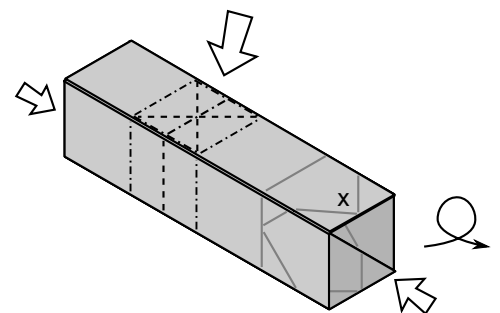

30. Collapse the Waterbomb  
bases on top and bottom. Turn  
over

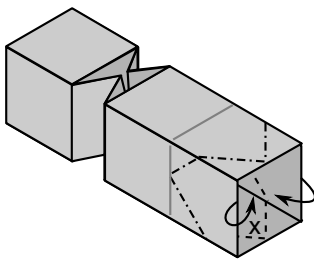

31. Mountain-fold on existing  
creases to make the mouth

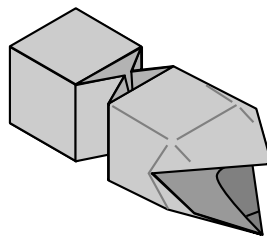

32. Head module finished

# Assembly

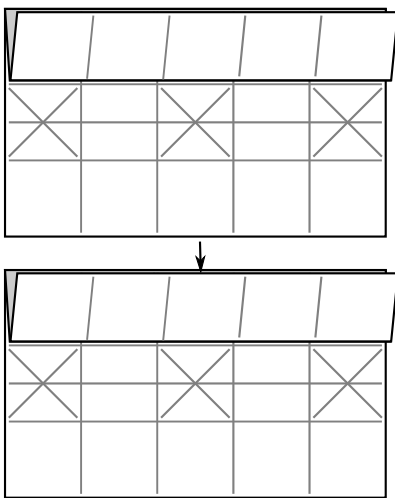
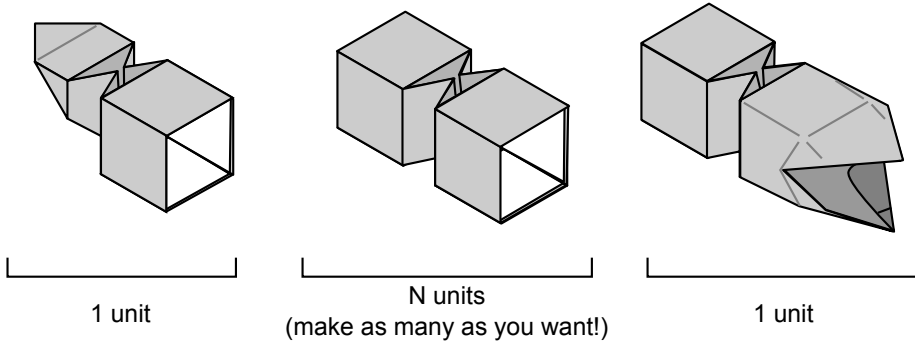

33. To connect the modules, unfold them. Insert the bottom of one module into the pleat of another

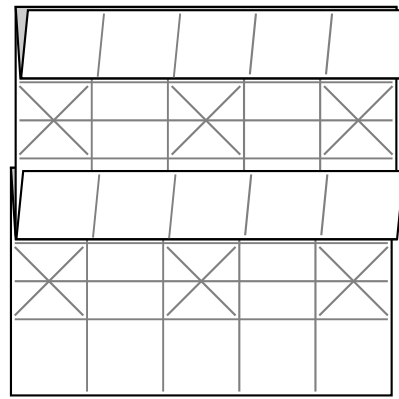

34. Then close the modules again. Before closing it, line up all the modules like this

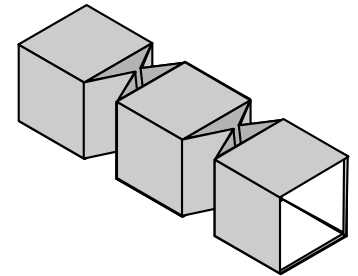

35. Two modules connected.

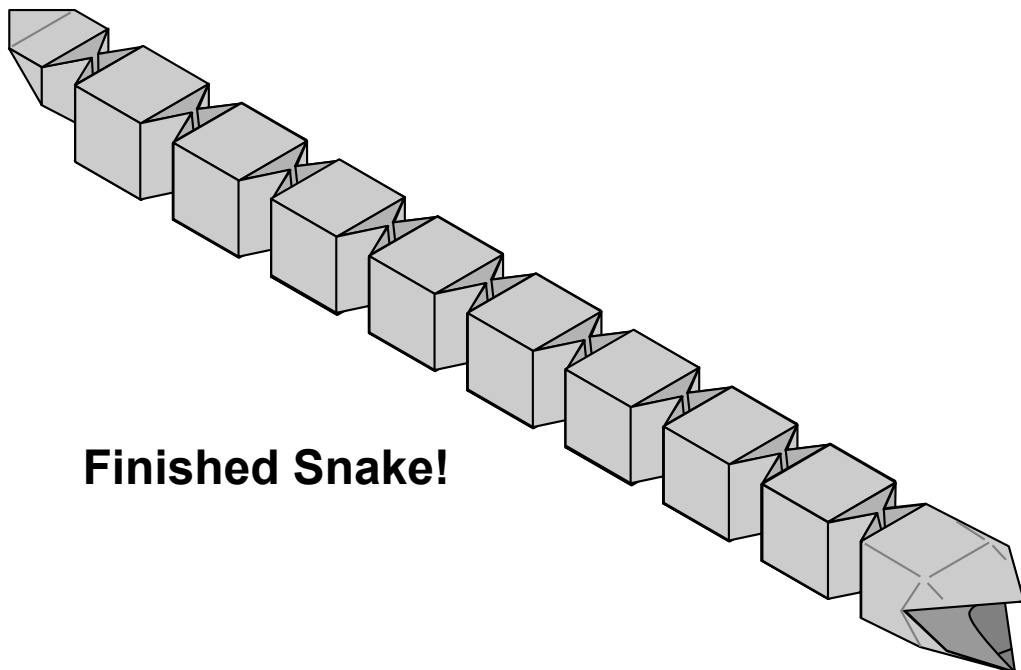

**Finished Snake!**