

# Heart Stand

Designed by Jo Nakashima

<http://jonakashima.com.br>  
<http://youtube.com/jonakashima>

Date: 31/Jan/2015

Difficulty Level: 1/5

Time to fold it: 5 minutes

Video: <http://youtu.be/Md3bfNITrhM>

Paper: 15cm x 15cm

- Standard paper
- Tissue foil
- Wet folding

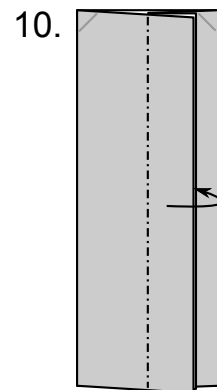
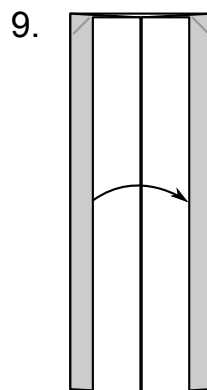
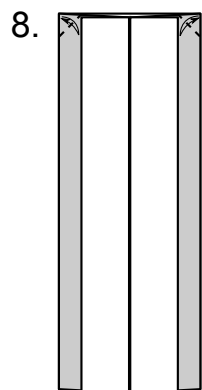
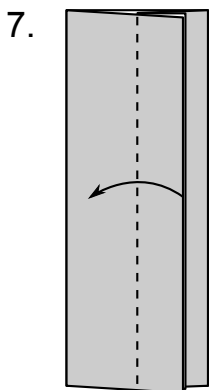
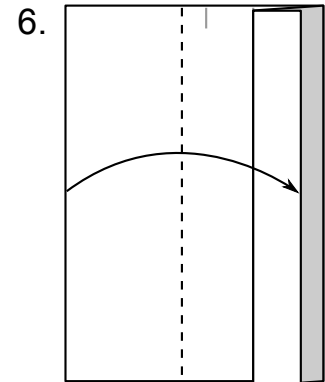
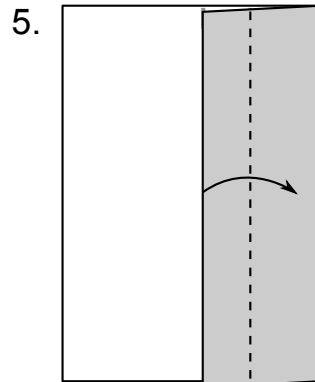
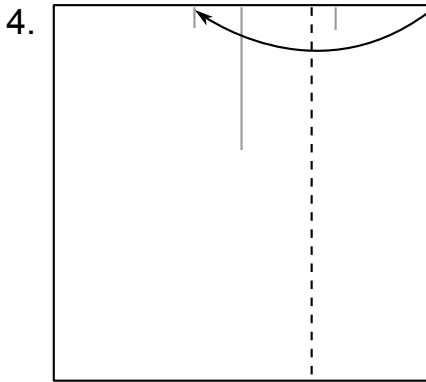
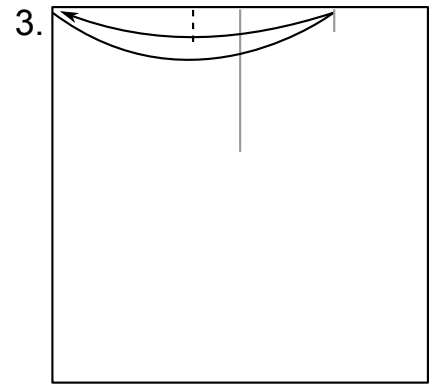
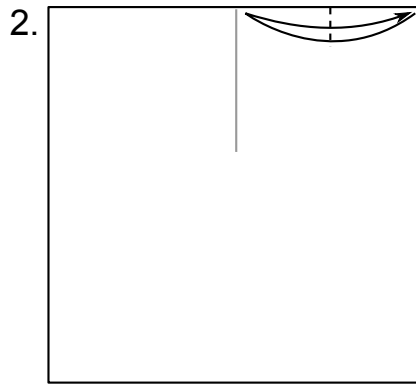
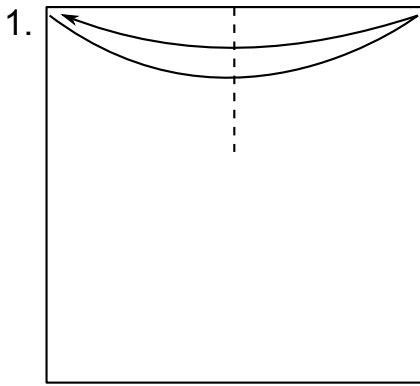

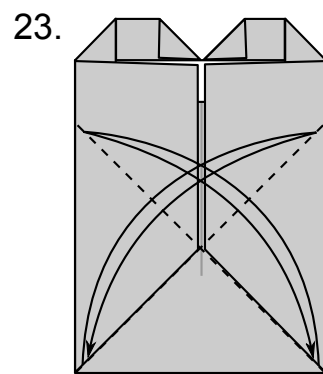
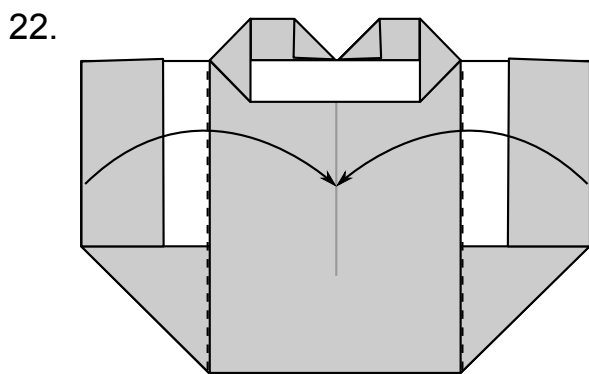
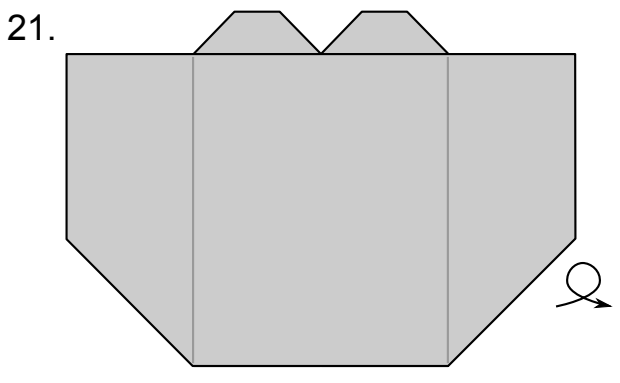
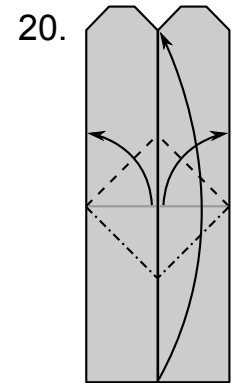
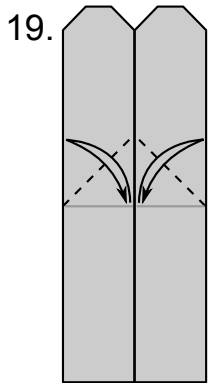
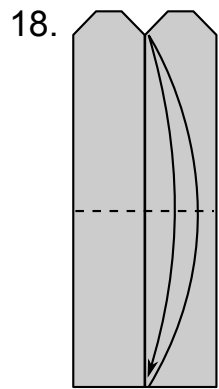
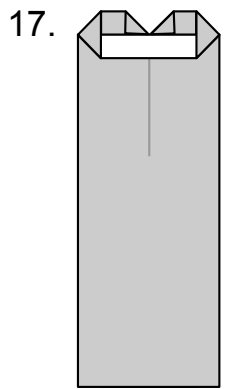
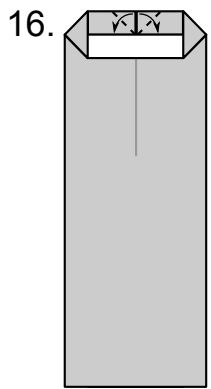
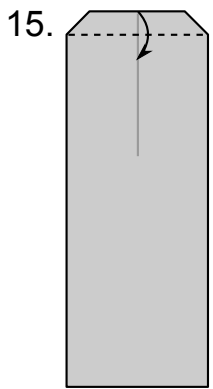
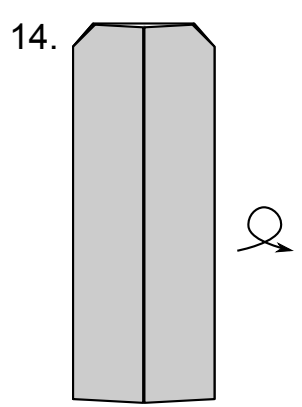
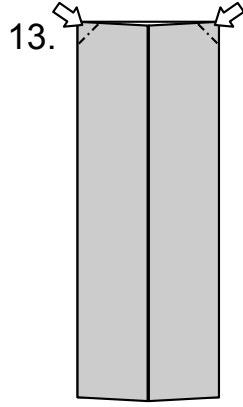
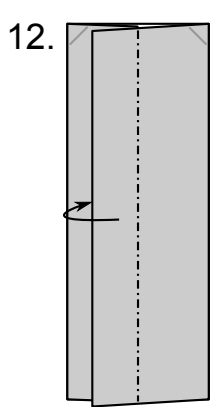
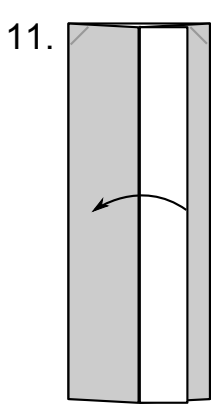

24.

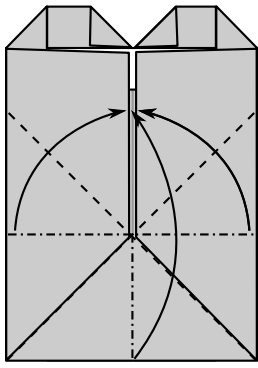

25.

