

Santa Claus

Designed by Jo Nakashima & Camila Zeymer

<http://jonakashima.com.br>
<http://youtube.com/jonakashima>

Date: 07/Nov/2015
 Difficulty Level: Simple
 Time to fold it: 15 minutes
 Video: <http://youtu.be/OmwhIOyoiHQ>

Paper: 15cm x 15cm

- Standard paper
- Tissue foil
- Wet folding

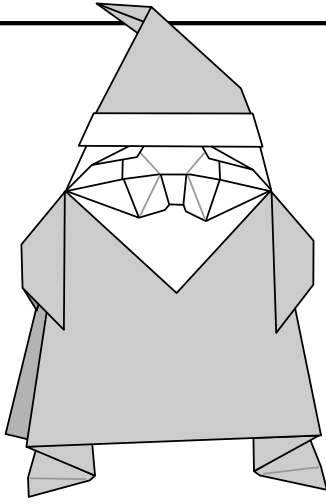

1.

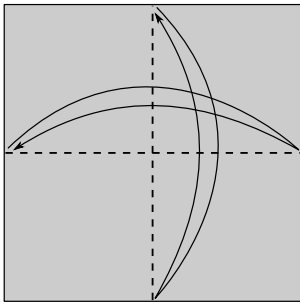

2.

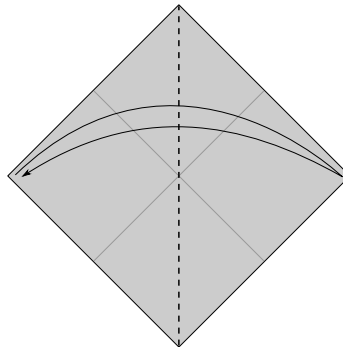

3.

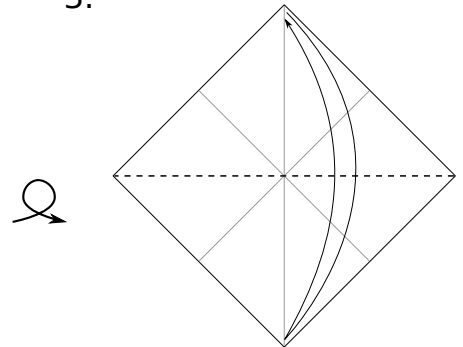

4.

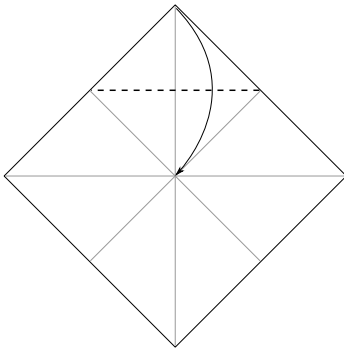

5.

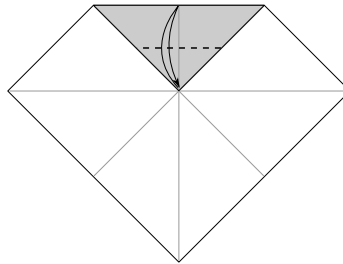

6.

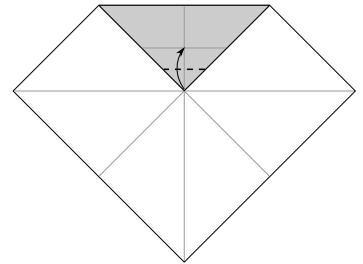

7.

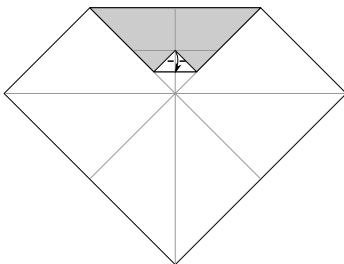

8.

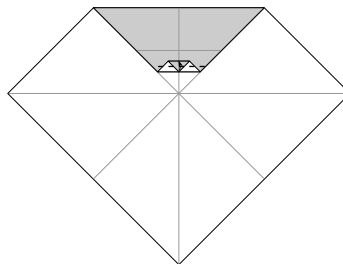

9.

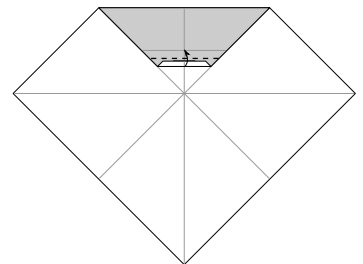

10.

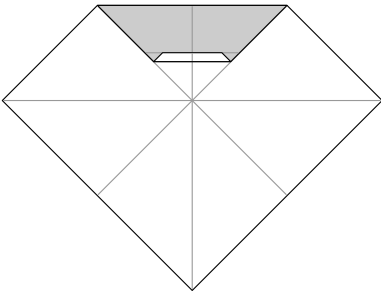

11.

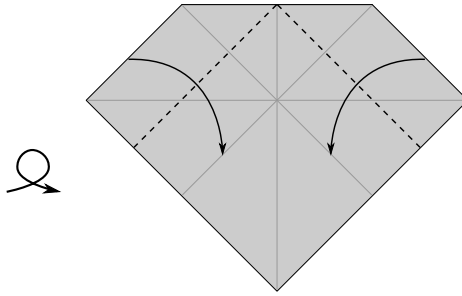

12.

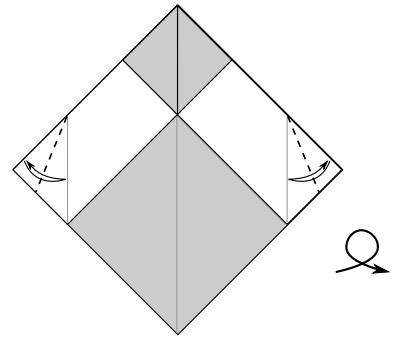

13.

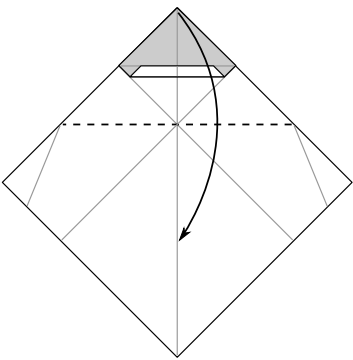

14.

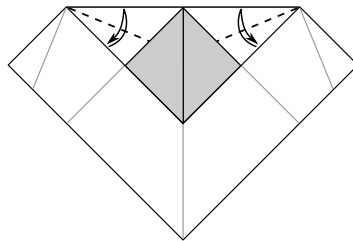

15.

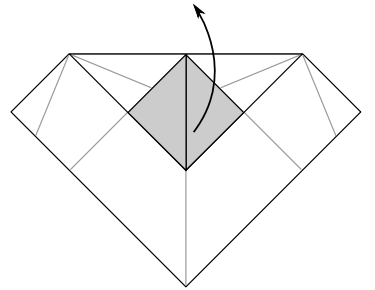

16.

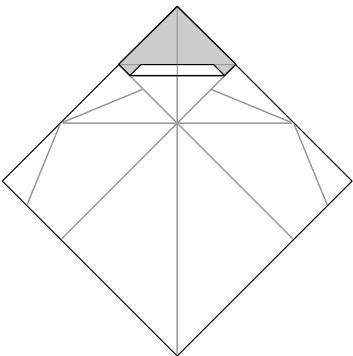

17.

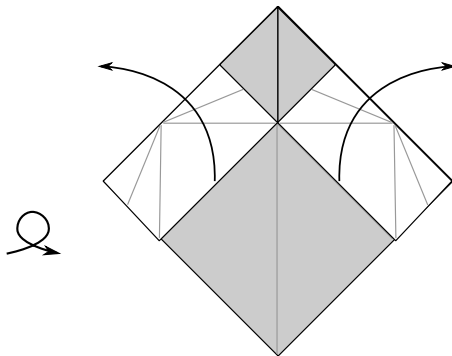

18.

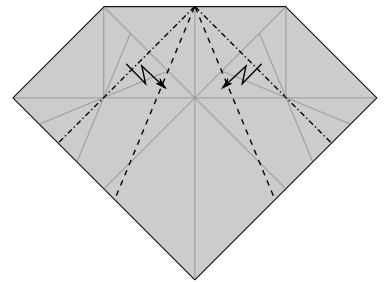

19.

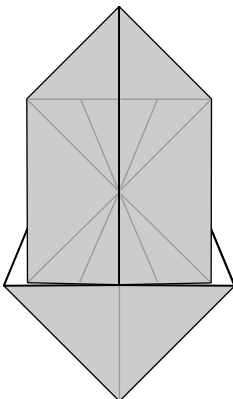

20.

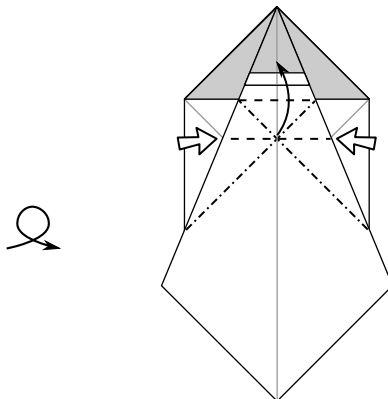

21.

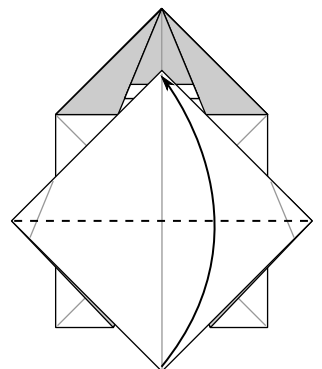

22.

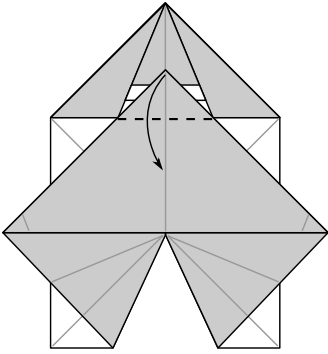

23.

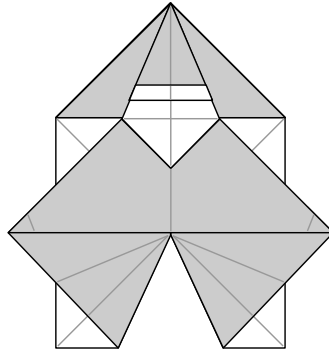

24.

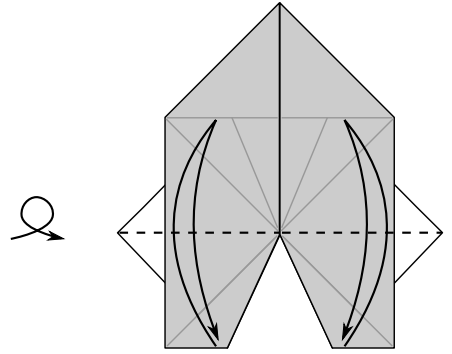

25.

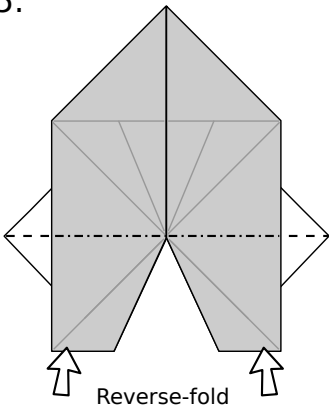

Reverse-fold

26.

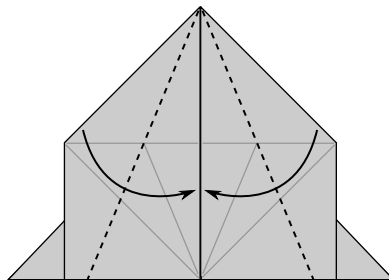

27.

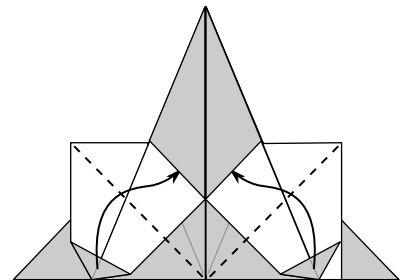

28.

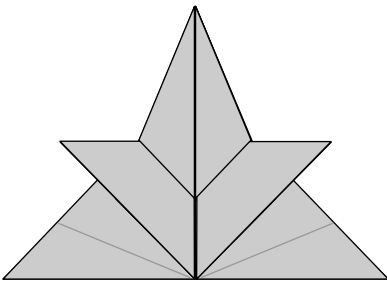

29.

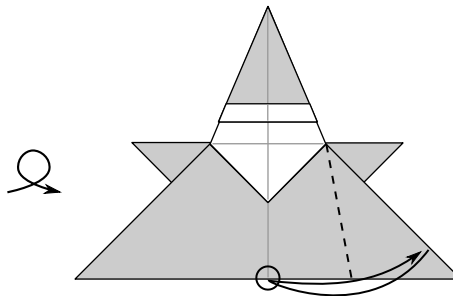

30.

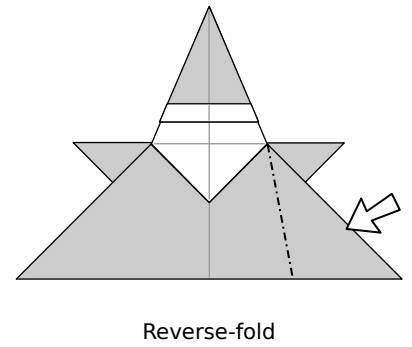

Reverse-fold

31.

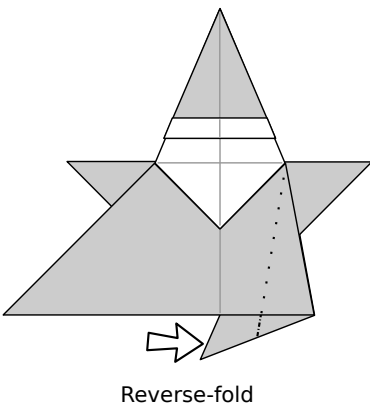

Reverse-fold

32.

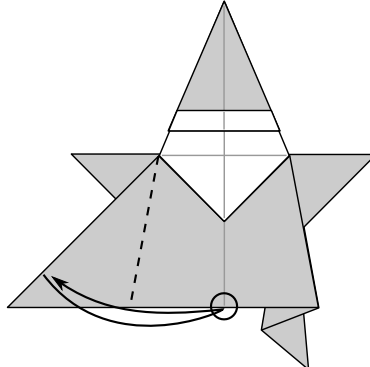

33.

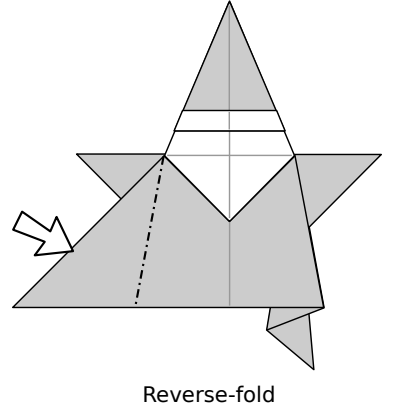

Reverse-fold

34.

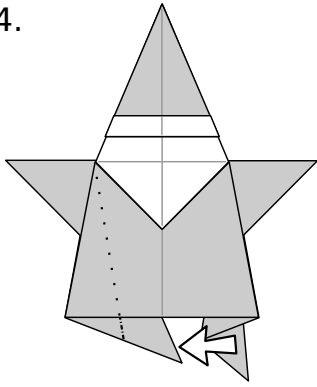

Reverse-fold

35.

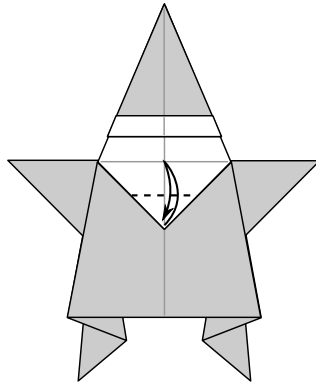

36.

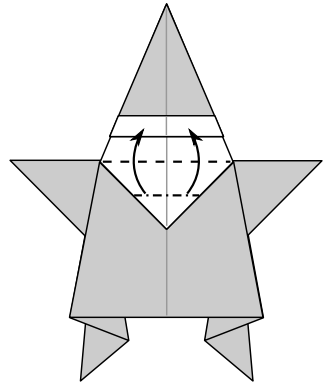

37.

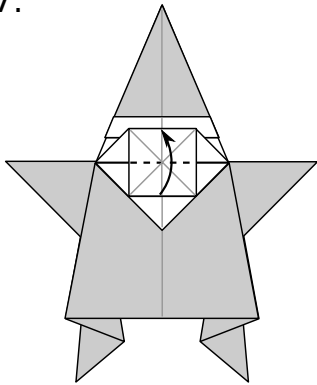

38

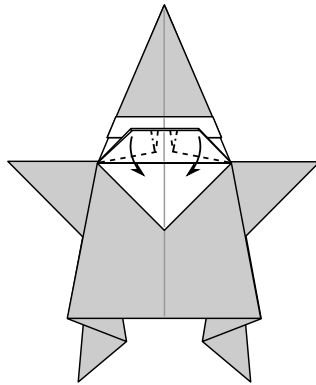

39.

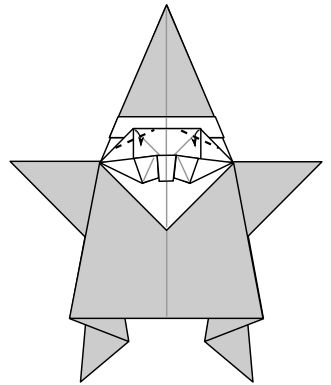

40.

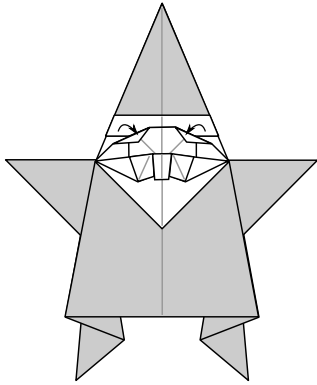

41.

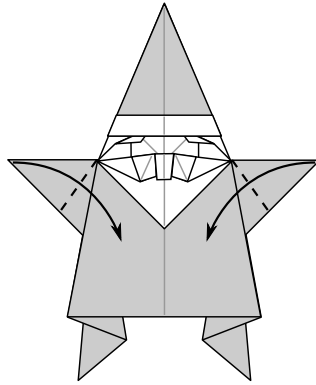

42.

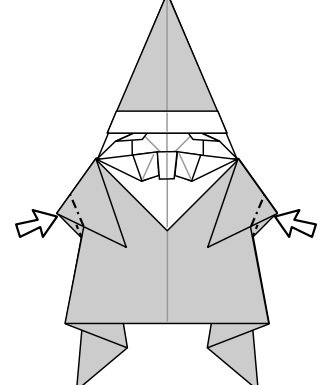

Cover the top of the head with the cap

43.

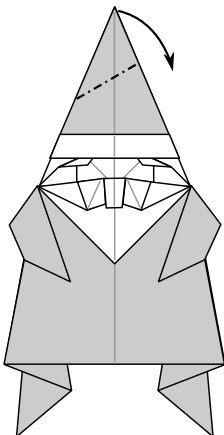

44.

